

## PI2 STANDARD SUSPENSION

### A300110-

base number    LED Dimming    Color Temperature    Finishes (Diamond)    Finishes (Triangle)    Diffuser Options    Cable Length

- To build a product code in our configurator select the specify button on the base model # product page
- To build a manual product code on this datasheet choose from the options listed below in blue font and add the suffix to the base model #

#### GENERAL

Series: Pi2  
 Subseries: Pi2 Standard  
 Brand: Prolicht  
 Division: Architectural  
 Mounting Type: Suspension  
 Mounting Location: Ceiling  
 Subcategory: Ambient

#### PHYSICAL

Shape: Square  
 Length (mm): 600  
 Length (in): 23 <sup>5</sup>/<sub>8</sub>  
 Width (mm): 600  
 Width (in): 23 <sup>5</sup>/<sub>8</sub>  
 Height (mm): 60  
 Height (in): 2 <sup>3</sup>/<sub>8</sub>  
 Light Distribution: Direct / Indirect  
 Weight (kg): 9.9  
 Weight (lbs): 21.83  
 Diffuser: PMMA - Opal or Micro-Prism  
 Fixture Finish: SSR / BKV / CWI / CRY / HAB / LAG / UFT / ITA / RUA / RUR / MIC / FTG / MYG / TWT / LOD / PUS / FRO / FUP / KIA / POP / BLS / SPG / MEY / GOH / GUM / CHC / COM / ABZ / JAG / OBR / MOS / ROR  
 Fixture Material: Aluminum  
 Cable Details: 2000mm or 6000mm

#### ELECTRICAL

Lamp Type: LED (Zhaga Standard)  
 Input Wattage (W): 55  
 Total Output Wattage (W): 50  
 Dimming: Tri-Mode (Non-Dimming and Phase Dimming (120Vac only) and 0-10V Dimming)  
 Driver Included: Yes  
 Driver Location: Integrated  
 Driver Type: Constant Current - Universal  
 Driver Class: Class 2  
 Input Voltage (V): 120 - 277  
 Constant Current (MA): 350

#### LED

Color Temperature (°K): 3000 / 3500 / 4000  
 Max. Delivered Lumen (lm): 5710 / 5802 / 5920  
 CRI: >80 CRI  
 Efficiency (%): 0.65  
 Lamp Life (hrs): 50000

#### OPTICAL

#### RATINGS AND CERTIFICATIONS

Certified By: Certified for North American Standards  
 IP rating: IP20



## PI2 STANDARD SUSPENSION

A300110-

PROJECT

TYPE

SPECIFIER

QUANTITY

DATE



## PI2 STANDARD SURFACE

### A32334-

base number    LED Dimming    Color Temperature    Finishes    Diffuser Options

- To build a product code in our configurator select the specify button on the base model # product page
- To build a manual product code on this datasheet choose from the options listed below in blue font and add the suffix to the base model #

#### GENERAL

Series: Pi2  
 Subseries: Pi2 Standard  
 Brand: Prolicht  
 Division: Architectural  
 Mounting Type: Surface  
 Mounting Location: Ceiling

#### PHYSICAL

Length (mm): 600  
 Length (in): 23 5/8  
 Height (mm): 600  
 Height (in): 23 5/8  
 Extension (mm): 60  
 Extension (in): 2 3/8  
 Light Distribution: Direct  
 Weight (kg): 9.5  
 Weight (lbs): 20.94  
 Diffuser: PMMA - Opal or Micro-Prism  
 Fixture Finish: SSR / BKV / CWI / CRY / HAB / LAG / UFT / ITA / RUA / RUR / MIC / FTG / MYG / TWT / LOD / PUS / FRO / FUP / KIA / POP / BLS / SPG / MEY / GOH / GUM / CHC / COM / ABZ / JAG / OBR / MOS / ROR

#### ELECTRICAL

Lamp Type: LED (Zhaga Standard)  
 Input Wattage (W): 55  
 Total Output Wattage (W): 10  
 Dimming: Tri-Mode (Non-Dimming and Phase Dimming (120Vac only) and 0-10V Dimming)  
 Driver Included: Yes  
 Driver Location: Integrated  
 Driver Type: Constant Current - Universal  
 Driver Class: Class 1  
 Input Voltage (V): 120 - 277  
 Constant Current (MA): 350

#### LED

Color Temperature (°K): 3000 / 3500 / 4000  
 Max. Delivered Lumen (lm): 5368  
 Nominal Lumen (lm): 6680  
 CRI: >80 CRI  
 Efficiency (%): 0.81  
 Lamp Life (hrs): 50000

#### OPTICAL

#### RATINGS AND CERTIFICATIONS

Certified By: Certified for North American Standards

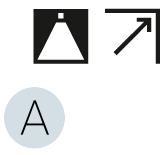
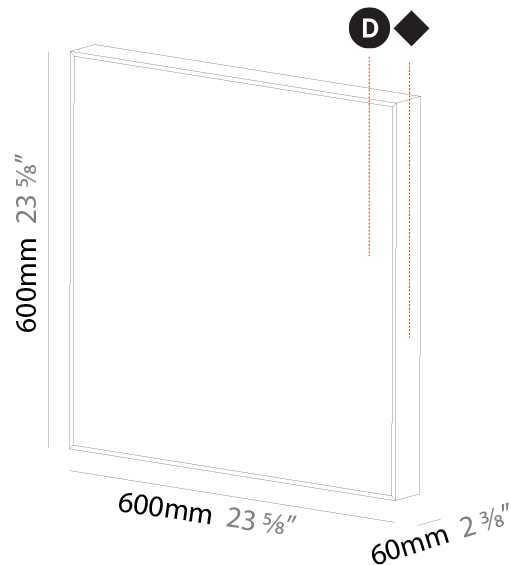

A32334-

PROJECT \_\_\_\_\_

TYPE \_\_\_\_\_

SPECIFIER \_\_\_\_\_

QUANTITY \_\_\_\_\_

DATE \_\_\_\_\_

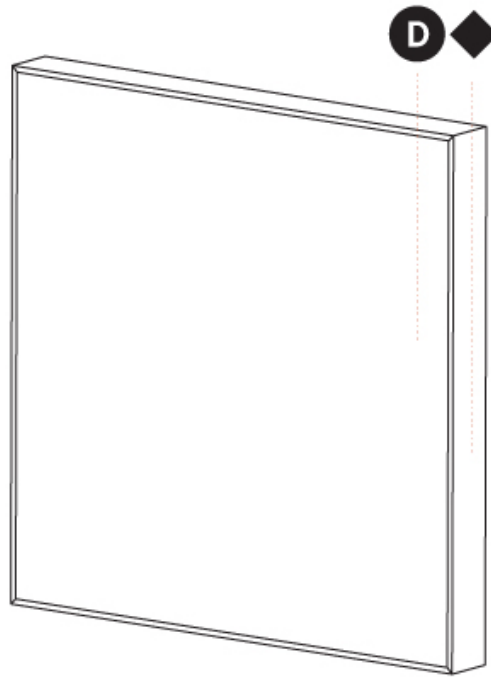

## PI2 STANDARD TRIMLESS

**A36389-** -

base number LED Dimming Color Temperature

- To build a product code in our configurator select the specify button on the base model # product page
- To build a manual product code on this datasheet choose from the options listed below in blue font and add the suffix to the base model #

### GENERAL

Series: Pi2  
 Subseries: Pi2 Standard  
 Brand: Prolicht  
 Division: Architectural  
 Mounting Type: Trimless  
 Mounting Location: Ceiling  
 Subcategory: Ambient

### PHYSICAL

Shape: Square  
 Length (mm): 600  
 Length (in): 23 5/8  
 Width (mm): 600  
 Width (in): 23 5/8  
 Height (mm): 150  
 Height (in): 5 7/8  
 Ceiling Thickness (mm): 10 / 12.5 / 15 / 25 / 30  
 Ceiling Thickness (in): 3/8 or 1/2 or 9/16 or 1 or 1 3/16  
 Min. Recessing Depth (mm): 180  
 Min. Recessing Depth (in): 7 1/8  
 Light Distribution: Direct  
 Diffuser: PMMA - Opal  
 Fixture Finish: SSR / BKV / CWI / CRY / HAB / LAG / UFT / ITA / RUA / RUR / MIC / FTG / MYG / TWT / LOD / PUS / FRO / FUP / KIA / POP / BLS / SPG / MEY / GOH / GUM / CHC / COM / ABZ / JAG / OBR / MOS / ROR  
 Fixture Material: Aluminum  
 Cut-out Measurements: 635mm / 25" x 635mm / 25"  
 Upon Request: Unique Sizes Unique Ceiling Thickness Unique Mounting Depth Spot Inserts

### ELECTRICAL

Lamp Type: LED (Zhaga Standard)  
 Input Wattage (W): 55  
 Total Output Wattage (W): 46  
 Dimming: Tri-Mode (Non-Dimming and Phase Dimming (120Vac only) and 0-10V Dimming)  
 Driver Included: Yes  
 Driver Location: Integrated  
 Driver Type: Constant Current - Universal  
 Driver Class: Class 2  
 Input Voltage (V): 120 - 277  
 Constant Current (MA): 350

### LED

Color Temperature (°K): 3000 / 3500 / 4000  
 Max. Delivered Lumen (lm): 4350 / 4410 / 4500  
 CRI: >80 CRI  
 Efficiency (%): 65% (5mm Perspex)|65.10%  
 Lamp Life (hrs): 50000  
 Upon Request: RGB-W Tunable White Special Color Temperature CRI90

### OPTICAL

#### RATINGS AND CERTIFICATIONS

Certified By: Certified for North American Standards  
 IP rating: IP20

PROJECT
TYPE
SPECIFIER
QUANTITY
DATE



## PI2 STANDARD TRIMLESS

A36389-

PROJECT

TYPE

SPECIFIER

QUANTITY

DATE



PROJECT \_\_\_\_\_  
 TYPE \_\_\_\_\_  
 SPECIFIER \_\_\_\_\_  
 QUANTITY \_\_\_\_\_  
 DATE \_\_\_\_\_

### Fixture Finish



**Digital:** Not all screens are calibrated the same, and therefore, colors will appear differently between devices.  
**Physical:** When texture is involved, there will be variations in color, character and tone within a product and between product families.







































































**Gun Metal:** No Gun Metal finish is alike. It combines a mixture of transparent and black color particles to ensure a highly individual effect and no luminaire being identical.  
**Champagne Cream, Copper Mine, Ancient Bronze & Jazz Gold:** These finishes have slight fading from specific powder coating production. Each luminaire will slightly vary.











Zaneen Group LLC • 2024 • 11300 Park 53rd, #406 • Denver, CO 80231 • www.zaneen.com  
 Available for International specifications by adding 'INT' at the end of the existing Model #. For assistance on 'custom' specifications, contact zteam@zaneen.com.  
 In a constant effort to supply the best product, we reserve the right to change specifications or materials without notice. The most recent specification sheets are found at zaneen.com

PROJECT	
TYPE	
SPECIFIER	
QUANTITY	
DATE	











## LEGEND

 floor-mounted	 pivotable	 special LED (upon request) RGB, RGBW, tunable, gold+, meat+, art+, fashion+
 wall and ceiling: recessed and surface mounted	 rotating	 warm dim / natural dimming LED
 ceiling-mounted and wall-mounted	 illuminate tilted	 rechargeable battery powered
 wall-mounted	 color of suspension cable	 fixture with natural vivid LED (upon request)
 omni-directional light distribution	 length of suspension cable	 color rendering index
 direct light distribution	 reflector degree selection	 color temperature
 direct/indirect light distribution	 super spot	 lumen (luminous flux)
 indirect light distribution	 lens	 efficacy (lumens per watt)
 asymmetric light distribution	 lens pack	 Unified Glare Rating (UGR) range from 5-40
 aura light distribution	 shine ring	 marine grade (AISI 316 stainless steel)
 round wall or ceiling cut-out	 integrated shine ring with diffuser	 walk on
 square wall or ceiling cut-out	 free individual colors 01-29	 drive on
 the supplied jig specifies the cutout dimensions	 individual colors: 00 (free of charge), 01-25 (extra charge)	 Dark Sky Compliance
 minimum distance (meters) lamp - object	 luminaire part to be colored (F1)	 Americans with Disabilities Act (less than 4" off the wall located between 27"-84" from floor)
 recessed depth	 luminaire part to be colored (F2)	 lamp protected against explosion
 ceiling thickness in mm	 luminaire part to be colored (F3)	 blown glass using traditional methods by master glass blower
 ceiling thickness selection	 luminaire part to be colored (F4)	 acoustic material
 dimmable DP (phase), DV (0-10V), DD (dali), DS (step-dim)	 luminaire part to be colored (F5)	 protection class I, protection insulation
 included or excluded LED driver/transformer/control gear	 color of 3-circuit adaptor	 protection class II, protection insulation
 separately switchable	 indirect diffuser	 ETL Certified to UL and CSA Standards
 sensor	 direct diffuser	 UL Certified to UL and CSA Standards
 remote control	 ball-proof (upon request)	 CSA Certified to UL and CSA Standards
 available upon request	 accessory	 Certified for North American Standards

## IP RATING

 IP20	protected against ingress of solid bodies greater than 12.5mm (finger)
 IP33	protected against ingress of solid bodies greater than 2.5mm protected against sprays of water up to 60 degrees from the vertical (rain)
 IP40	protected against ingress of solid bodies greater than 1mm (wire) no protection against the ingress of moisture
 IP43	protected against ingress of solid bodies greater than 1mm (wire) protected against sprays of water up to 60 degrees from the vertical (rain)
 IP44	protected against ingress of solid bodies greater than 1mm (wire) protected against water splashed from all directions
 IP54	protected against limited ingress of dust (wet rooms/covered outdoor areas) protected against water splashed from all directions
 IP65	protected against ingress of dust protected against jets of water
 IP66	protected against ingress of dust protected against powerful jets of water or heavy seas
 IP67	protected against ingress of dust protected against immersion of water between 15cm - 1m for 30 minutes
 IP68	protected against ingress of dust protected against immersion of water under pressure for long periods

## IK RATING

 IK01	protected against 0.14 joules impact (equivalent to 0.25kg mass dropped from 56mm above the surface)
 IK02	protected against 0.2 joules impact (equivalent to 0.25kg mass dropped from 80mm above the surface)
 IK03	protected against 0.35 joules impact (equivalent to 0.25kg mass dropped from 140mm above the surface)
 IK04	protected against 0.5 joules impact (equivalent to 0.25kg mass dropped from 200mm above the surface)
 IK05	protected against 0.7 joules impact (equivalent to 0.25kg mass dropped from 280mm above the surface)
 IK06	protected against 1 joules impact (equivalent to 0.25kg mass dropped from 400mm above the surface)
 IK07	protected against 2 joules impact (equivalent to 0.5kg mass dropped from 400mm above the surface)
 IK08	protected against 5 joules impact (equivalent to 1.7kg mass dropped from 300mm above the surface)
 IK09	protected against 10 joules impact (equivalent to 5.0kg mass dropped from 200mm above the surface)
 IK10	protected against 20 joules impact (equivalent to 5.0kg mass dropped from 400mm above the surface)